

Made In Australia

Taylex Tanks

Since 1969

Wastewater &
Rainwater Specialists



On-Site Wastewater
Treatment Solutions

Concrete & Plastic



Taylex has a system for every Australian effluent category

1300 TAYLEX

www.taylex.com.au

About Taylex

Taylex was founded in 1969 and was the first company to manufacture Aerobic Wastewater Treatment Systems (AWTS) in Australia. Taylex continues to lead the field in both precast concrete and rotational moulding manufacturing, design & installation of Rainwater Tanks and Aerobic Wastewater Treatment Systems (AWTS) or Home Sewage Treatment Plants (HSTP).

Taylex has a National Distribution Network which is supported by factory trained licensed distributors. Our distributors can supply, install, service and maintain our range of both concrete and plastic products from Tasmania to Darwin, Perth to Brisbane. We manufacture all our own concrete and plastic products.



Taylex is a Quality Assured Company that works under ISO 9001. Our range of products carries all relevant State Government Approvals throughout Australia.

Installation & Commissioning

Your Taylex consultant will project manage your install with your builder and plumber. They will advise on and discuss matters with you that may affect the final outcome for you (eg sub-surface rock, positioning of tanks, etc.). This ensures a trouble free install with maximum aesthetic value and minimal environmental impact. After the install your builder will go about his job until your house is finished. Please make sure your builder arranges a commissioning date for your system at least 2 weeks prior to your move in date.

Servicing

Home Sewage Treatment Plants are required by law to be serviced on a regular basis (normally quarterly unless otherwise stated). Your Local Council will enforce these laws. Systems may only be serviced by registered licensed wastewater service personnel. At Taylex our friendly servicemen will attend your new plant free of charge for the first 12 months. After the first year you can renew your service contract with us on a yearly basis.

Please note: All aerated and septic systems need to be pumped out depending on usage. On average most Taylex systems need to be pumped out between 7 to 10 years. Any claims by other companies that their tanks never have to be pumped out are incorrect as some solid matter that households produce cannot be digested or dissolved.

15 Year Warranty

Every Taylex concrete or plastic system is covered by a full manufacturer's warranty. IMPORTANT: The Taylex 15 year warranty on both concrete and plastic vessels (tanks) extends to the internal compartment walls as they are poured or moulded in one piece and can never dislodge. A 3 year* warranty on all electrical and mechanical components including the irrigation pump (*12 month standard warranty and a further 24 months extended warranty when you purchase your 2nd & 3rd years of service calls with a Taylex Approved Service Provider). Warranties apply from the date of commissioning or 90 days from the date of installation (whichever is sooner).

Taylex Tanks are purpose built - As A One Piece Moulded Unit

Eliminating any leakage caused by movement of internal walls - a common problem with other tanks that have mortar or silicone joints internally. This would allow contamination between compartments, hindering the treatment process and allowing untreated water to be irrigated into your garden. TAYLEX TANKS NEVER REQUIRE A REBUILD. We believe we make the best concrete and plastic vessels for a treatment system in Australia.

Taylex Tanks are Full Wall Tanks and larger than most.

The period of time effluent is able to process in your tank is the secret to producing quality effluent. Our tanks can accommodate more water so your effluent is consistently treated for longer - even on high usage days. This accommodates for growth of your family and when visitors arrive. The walls in each compartment extend to the top of the tank so shock loads of effluent will not flood the tank and result in cross contamination of the compartment contents.

Monitoring and Alarms

Taylex Systems all have two alarms systems by law (1 x Audible & 1 x Visual). This will alert you to a problem and prompt you to call in a Service Technician or consult your Home Owner's Manual (provided in the control box on your tank, our website or available by calling our service department). Once you are aware of the problem you can mute the alarm while you wait for the serviceman. It cannot be forgotten as it will reactivate every 24 hours until a remedy has been found.

We have chosen not to have the monitoring system placed in your house to reduce inconvenience to you. The Taylex Systems are large enough that it is unnecessary to wake a sleeping family in the middle of the night. It also allows our servicemen to work on your system if you are not at home should a breakdown ever occur.

Power Usage & Diagnostic Controllers

While the Taylex vessels (tanks) are suitable for a large house the "systems" can be turned down electrically to cater for the individual household usage. The Advanced Blower System uses controllers that have the ability to turn the air blower on and off during the hour if required - unlike other units that run 24 hours a day. This can be changed as the needs of the household change (if the household grows or diminishes.) Your friendly servicemen will monitor the health of the system and adjust the running time if required.

Taylex have a System for every Australian Effluent Standard.

Please see the matrix to the right which outlines all our systems to determine which one produces the effluent quality required for your property. Your Local Distributor is always available to discuss your requirements with you.



Concrete & Plastic Tanks
15 Year Tank Warranty Includes
Internal Compartment Walls... Plus
3 Years Electrical Components Warranty*

*ABS and MAXI Systems Only

On-Site Sewage Treatment

Effluent Categories in Australia

Taylex has a system for every effluent category

Effluent Grade	Primary (Septic) / Advanced Primary (Septic)	Secondary	Advanced Secondary + Nutrient Reduction
Environmental Grade <small>Min. Australian Standard Requirements</small>	★ ★	★ ★ ★	★ ★ ★ ★ ★

Taylex Systems

Our Most Popular System

	Concrete OR Plastic	Concrete OR Plastic	Concrete OR Plastic
1 - 8 Bedrooms	3900Lt 7100Lt MAXI	COMPACT Discontinued	ABS Advanced Blower System
6 - 10 Bedrooms	7100Lt 10000Lt MAXI	DELUXE	2 x ABS
Commercial	Taylex Standard and Custom Designed Commercial Systems - Please speak to your Sales Consultant		

Specifications

Fact Sheets Available on subsequent pages of this brochure

Tank Construction Concrete Plastic	✓ —	✓ ✓	✓ —	✓ ✓
Irrigation Area Above Ground Below Ground <small>Subject to Council Approval</small>	✓ ✓	✓ ✓	✓ ✓	✓ ✓
Tank Configuration <small>Number of Tanks</small>	Up To 3 Tanks	1 Tank	2 Tank	1 Tank
Total Tank Capacities	7,100Lt	4,000Lt 5,300Lt	Concrete 9,320Lt	Plastic 7,100Lt
Disinfection	Nil	Nil	Chlorine*	Chlorine* or UV Light - No Chemical
Installation	✓	✓	✓	✓
Service Costs <small>*These prices may vary from area to area</small>	Nil	Nil	\$260-450 p/a (4 Services)	\$260-450 p/a (2-4 Services)
Electricity Usage	.5kW If required	.5kW If required	3 + kW	1.5 - 3kW**

* While Chlorine is used as a disinfectant, the output levels are no greater than a standard swimming pool.

** This system can be timed depending on the amount of waste water produced by the household

Australian Standards Requirement with Taylex Results

Effluent Grade	Primary / Septic	Secondary	Advanced Secondary + Nutrient Reduction	
	Australian Standard	Australian Standard	Australian Standard	TAYLEX ABS
BOD₅ <small>Biological Oxygen Demand Over 5 Days</small>	120 - 240mg/L	<20mg/L	<10mg/L	<1.85mg/L
TSS <small>Total Suspended Solids</small>	65 - 180mg/L	<30mg/L	<10mg/L	<5.19mg/L
Thermotolerant Coliforms	n/a	<200/100mL	<10/100mL	<0.783/100mL
Nitrogen	n/a	n/a	n/a	<25mg/L
Phosphorus mg/L	n/a	n/a	n/a	<5mg/L
Turbidity* <small>Clarity</small>	>13NTU	n/a	n/a	5.22NTU

Official Independent 6 Month Test Results

In comparison

*The WHO (World Health Organization), establishes that the turbidity of drinking water shouldn't be more than 5 NTU, and should ideally be below 1 NTU.

Taylex™ ABS One Piece Plastic or Concrete Tank

Why install a Taylex™ ABS?

If you live in an unsewered area, you will be required to install a system to treat your wastewater. It is your responsibility to ensure that you protect your family and the environment from potentially harmful substances. By installing a Taylex™ ABS you will be ensuring that you treat all your household wastewater to the highest level available. The treated effluent from a Taylex™ ABS is classified as advanced secondary which means that it is approximately 65 times cleaner than septic tank effluent, (which cannot be used for irrigation as it is a Health Hazard) and at least 5 times cleaner than effluent from most other treatment systems.

What makes the Taylex™ ABS different from other systems?

The Taylex™ ABS is a specially designed and manufactured one tank system that is made from either concrete or plastic. All of the internal walls are poured or moulded at the same time as the outer wall. We use steel reinforcing to make our concrete tank extremely strong and durable and fireproof. We use sandwiched closed cell polymer foam to make our plastic tank light, strong and durable. We do not use sealants or glues to seal our chambers as these will fail over time resulting in contamination of the treated effluent. We also do not use flimsy materials inside our tanks for walls or baffles. Our systems are designed to last as long as your house without ever having to be structurally rebuilt.

The Taylex™ ABS does not need more than one tank to achieve its extremely clean effluent quality. We have found by experience that two or three tank systems have the disadvantage of buried interconnecting pipework which can fail during backfilling and subsequent earth subsidence and compaction, resulting in raw sewage entering the environment and endangering your family's health.

Full Wall Construction

Both the concrete and plastic tank has been manufactured with internal walls that extend to the lid of the tank. This creates a larger than average buffer area to accommodate shock loads of waste that would normally cause flooding and contamination in a system. The lid of the tank contacts the top of the chamber walls to prevent solids transfer within the tank.

Self Anchoring Tank

The plastic tank is built with anti-floatation protrusions incorporated into the design. There is no need for chains or concrete to hold the tank in the ground. The concrete tank is 6.25 tonne which is enough weight to stop the tank from floating under normal operation.

Low Occupancy Mode and Self Diagnostic Control Panel

Taylex™ has designed its control panels to be self diagnostic. An alarm code will be displayed if anything abnormal occurs within your Taylex™ ABS. A phone call to your local service technician may be all that is required to rectify the situation, saving you time and money. The blower operation time is programmable at the control panel and run times can be varied to suit the number of people in the home and therefore reducing electricity usage.

Effluent Disposal Fields - (Irrigation)

Your local council will stipulate the type effluent disposal allowable in your area. Ask your Taylex Distributor to organise an essential Wastewater Disposal Report to ascertain if surface or sub-surface irrigation is to be used.

The 5 Step Process

Step 1: All wastewater from the home flows by gravity into the primary pre-treatment chamber of the Taylex™ ABS, and then into the secondary pre-treatment chamber by way of a mid-water take off. Solids are allowed to settle to the bottom of these chambers and a crust forms on the top. This naturally occurring crust stops odour from escaping from these chambers. Anaerobic (no oxygen) bacteria establish themselves in these chambers and partially digest the organic matter. Any untreatable and potentially harmful solids are retained within these chambers. The mid-water liquor between the bottom sludge based layer and the surface crust then flows by displacement into the aeration chamber.

Step 2: Air is introduced into the aeration chamber by way of a silent Blower with a Taylex™ air diffuser located at the bottom of the chamber. Aerobic (oxygen loving) bacteria proliferate and digest most of the remaining organic material. Fixed biomedica assist the retention and growth of the biomass.

Step 3: The liquid then flows into the clarification chamber for final settling. Sludge is removed from this chamber via an air sludge lift and is returned to the primary pre-treatment chamber for further treatment.

Step 4: The treated effluent passes through the Taylex™ TFG plate filter to settle out any floating solids and then through a solid chlorine tablet chlorinator, or UV light* to kill any viruses or pathogens that may remain in the treated effluent. The treated effluent is stored in the irrigation chamber until sufficient water activates the automatic submersible irrigation pump via a float switch.

Step 5: The automatic irrigation pump returns the treated effluent to the irrigation field for reuse in the environment.

Australian Standards & Test Results		
Effluent Grade	Advanced Secondary	
	Australian Standard	TAYLEX ABS
BOD5 Biological Oxygen Demand Over 5 Days	<10 mg/L	<1.85mg/L
TSS Total Suspended Solids	<10 mg/L	<5.19mg/L
Thermotolerant Coliforms	<10/100mL	<0.783/100mL
Nitrogen	n/a	<25mg/L
Phosphorus g/m3	n/a	<5mg/L
Turbidity Clarity	n/a	5.22NTU

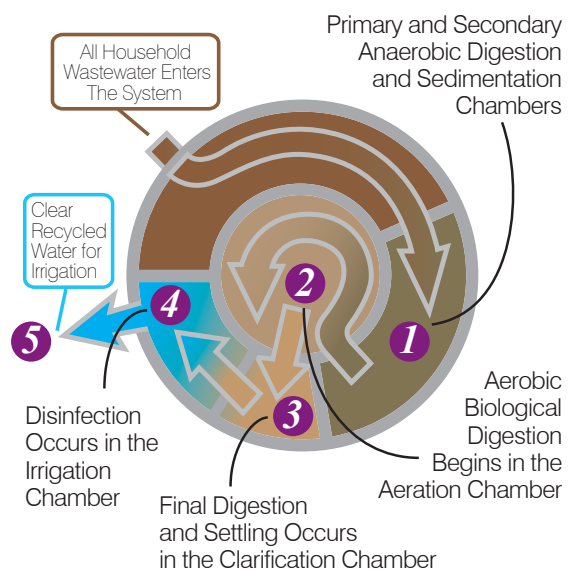

Our Most Popular System

Sewage Treatment Plant

Taylex™ **ABS** Advanced Blower System

An Advanced Secondary Aerated Wastewater Treatment System

Concrete *or* Poly

SOLAR POWER COMPLIANT

The Taylex ABS is suited to approximately 90% of all domestic installations throughout Australia.

Purchasing this system gives you an automatic upgrade to **Advanced Secondary** treated effluent.

This higher grade effluent system not only produces better quality water, but also offers **power saving**, **silent operation** and now chemical free disinfection (if required) at a similar price to most other secondary (lower effluent grade) systems on the market.

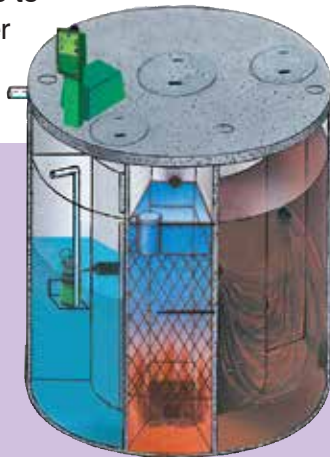

Even Our Standard System is Advanced!

Clear, odourless, recycled water for irrigation

Standard Tank All CONCRETE Vessel	10EP	8EP
Height	2300mm	2300mm
Tank Diameter	2450mm	2450mm
Maximum Dry Weight	6.25 tonnes	6.25 tonnes
Max. Hydraulic Loading	2,000Lt/day <small>(10 Person -13 Persons Old Only)</small>	1,200Lt/day <small>(8 Persons)</small>
Operating Capacity	5,880Lt	5,009Lt
Total Tank Capacity	9,320Lt	9,320Lt

Also available: Tall Tank versions 300, 400 & 800 (Weight 8-9 tonnes) & custom built Risers for deep inverts

STATE APPROVAL NUMBERS - Taylex Concrete Advanced Blower System

Queensland	17/2015 Chlorine -16/2015 UV
New South Wales	AWTS 026
Victoria	Global Cert. 040/8
Northern Territory	05/16
South Australia	WWP-59/15 & WWP-19/15
Western Australia	F-AA-51817
Tasmania	DOC/16/52075

Concrete Tank Inverts

From Ground Level	
Std	670mm
Tall 300	970mm
Tall 400	1070mm
Tall 800	1470mm
For 8EP Tanks ADD 200mm	

The Taylex Poly ABS is the world's first multi-chambered monolithic plastic tank built light and strong using a sandwiched, closed cell foam polymer manufacturing method. **No welded seams.**

When is a Poly Tank required?

The low weight of a poly tank makes it ideal

- for difficult access sites - eg. steep or
- if cranes are not easily available

Your Taylex Distributor will recommend the most suitable tank for your site.



Self Anchoring Advanced System

Clear, odourless, recycled water for irrigation

Standard Tank All PLASTIC Vessel	10EP	8EP
Height	2500mm	2500mm
Tank Footprint - Base	2400mm x 2530mm both	
Tank Diameter - Lid	2100mm	2100mm
Maximum Dry Weight	470kg *	470kg *
Max. Hydraulic Loading	2,000Lt/day <small>(10 Person -13 Persons Old Only)</small>	1,200Lt/day <small>(8 Persons)</small>
Operating Capacity	6,066Lt	5024Lt
Total Tank Capacity	7,100Lt	7,100Lt

* Allow 600kg as all tanks are water tested

STATE APPROVAL NUMBERS - Taylex Poly Advanced Blower System

Queensland	17/2015 Chlorine -16/2015 UV
New South Wales	AWTS 036
Victoria	Global Cert. 040/10
Northern Territory	05/16
South Australia	2012-08191 & WWP-18/15
Western Australia	F-AA-51817
Tasmania	DOC/16/52075

Poly Tank Inverts

From Ground Level	550mm
For 8EP Tanks ADD 200mm	

15 Year Tank Warranty Includes Internal Compartment Walls... Plus 3 Years Electrical Components Warranty

Taylex ABS Accreditation - Concrete

PRODUCT CERTIFICATION



GLOBAL CERTIFICATION PTY LTD

Certificate of Conformance *Product Performance Testing* *AS/NZS 1546.3:2008*

Number: 040/8

This Certificate of Conformance to the Product Certificate Scheme for "Domestic Wastewater Treatment Units (Septic Tanks) and Rainwater Tanks" remains the property of Global Certification Pty. Ltd. and is granted subject to the terms and conditions of the Contract Application, in respect of the Product certified on this page and the attached schedule to the Certification of Conformance, bearing the same number as this certificate.

Company: TAYLEX INDUSTRIES PTY LTD

Head Office Address: 56 PRAIRIE ROAD, ORMEAU QLD 4208

Recertification Date: 10 April 2016

Expiry Date: 11 July 2021

Product Certified:

Tank Type	Description	Total Size	Working Capacity	Additional Product Information	Manufacture & Assembly Points
Concrete ABS	Product manufactured using Collection Wells A,B, C,D,E,F,H,I,J total tank capacity 9,320 Lts, or using G & K Collection Wells total tank capacity 11,062 Lts. Secondary with Nutrient reduction at 53.71% for nitrogen and phosphorus removal at the 8EP and 10EP level using Chlorine as the disinfectant method.	9,320 Lt Or 11,062 Lt	10EP 5,880 Lt 8EP 5009 Lt	Over the test period the average results were: BOD ₅ 1.0 g/m ³ TSS 6.44 g/m ³ Total Nitrogen 24.9mg/L Total phosphorus 2.5mg/L E.Coli and faecal coliform ND in any sample at the dilutions tested Turbidity 6.25 NTU Dissolved Oxygen 5.6 mg/L Average Aeration Chamber Temperature 21.05°C	Manufactured and assembled at: 56 Prairie Road ORMEAU QLD 4208

5 November 2010

Certification Date

PO Box 195, Morayfield QLD 4506

Bruce Smith Director

Signed for and on behalf of Global Certification Pty Ltd

DATE OF ISSUE: 11 July 2016



www.jas-anz.com.au/register

© Global Certification Pty. Ltd. GC0050B R1 May 2013 Page 1

Taylex ABS Accreditation - Poly

PRODUCT CERTIFICATION



GLOBAL CERTIFICATION PTY LTD

Certificate of Conformance *Product Performance Testing* *AS/NZS 1546.3:2008*

Number: 040/10

This Certificate of Conformance to the Product Certificate Scheme for "Domestic Wastewater Treatment Units (Septic Tanks) and Rainwater Tanks" remains the property of Global Certification Pty. Ltd. and is granted subject to the terms and conditions of the Contract Application, in respect of the Product certified on this page and the attached schedule to the Certification of Conformance, bearing the same number as this certificate.

Company: TAYLEX INDUSTRIES PTY LTD

Head Office Address: 56 PRAIRIE ROAD, ORMEAU QLD 4208

Recertification Date: 10 April 2016

Expiry Date: 11 July 2021

Product Certified:

Tank Type	Description	Total Size	Working Capacity	Additional Product Information	Manufacture & Assembly Points
Taylex Poly ABS	Vertical Axis, rotational moulded Polyethylene Secondary Effluent at the 8EP and 10EP Level with Nutrient Reduction at 53.71% for Nitrogen and Phosphorus removal using Chlorine disinfection.	7,078 Lt	10 EP 6,036 Lt 8EP 5024 Lt	Average test Results achieved: BOD ₅ 1.0 g/m ³ TSS 6.44 g/m ³ Total Nitrogen 24.9mg/L Total phosphorus 2.5mg/L E.Coli and faecal coliform ND in any sample at the dilutions tested Turbidity 6.25 NTU Dissolved Oxygen 5.6 mg/L Average Aeration Chamber Temperature 21.05°C Free Chlorine 1.10mg/L	Manufactured and assembled at: 56 Prairie Road Ormeau QLD 4208

1 June 2012

Certification Date

PO Box 195, Morayfield QLD 4506

Bruce Smith Director

Signed for and on behalf of Global Certification Pty Ltd

DATE OF ISSUE: 11 July 2016



www.jas-anz.com.au/register

© Global Certification Pty. Ltd. GC0050B R1 May 2013

Why install a MAXI Tank All Purpose Advanced Septic Tank

Extend the life of septic trenches and absorption beds.

Better Effluent

A Taylex MAXI Tank produces better quality effluent than a standard septic tank. By acting like a large grease trap, and utilising the 5 chambered tank to slow F.O.G. (fats, oils and greases) down for digestion by bacteria. The discharged effluent is much clearer and free of solids and grease that will clog up and break down your trenches over time. Remember when you had to install a grease trap, back then trenches lasted longer than they do today.

Taylex Filter

The system is fitted as standard with a Taylex TFS Outlet Filter which adds to the protection by arresting any solids that may still be present at the time of effluent discharge to the trenches.

One Piece Tank

Whether concrete or plastic, the Taylex™ MAXI Tank has been constructed with 5 internal chambers that have a no underwater joins to leak or fail. Baffles (compartment walls) carry the same 15 year warranty that the tank body has.

Full Wall Construction

Both the concrete and plastic tank has been manufactured with internal walls that extend to the lid of the tank. This creates a larger than average buffer area to accommodate shock loads of waste that would normally cause flooding and contamination in a system. The lid of the tank contacts the top of the chamber walls to prevent solids transfer within the tank.

Quality Purpose Designed Components

At Taylex™ we believe that using the best quality materials is vital to the long term success of any wastewater treatment system. We only use materials that will withstand the harsh environment that they will be used in.

Fewer Pump-Outs Required

All septic tanks and treatment plants will require a pump out at some stage to remove the undigested solids in the tank. Standard septic tanks may require a pump out more often as they have only one or two chambers and do not allow the bacteria to digest solids efficiently in the overloaded effluent. As in Treatment Plants the Taylex Maxi has 5 chambers – the effluent in each one is a little cleaner and clearer than the previous chamber. This allows the bacteria to work more efficiently as the effluent makes its way to the disposal chamber.

GRAVITY or PUMP?

The Taylex Maxi Tank is made with gravity overflow outlet as standard, however it is easily fitted with an irrigation pump and high water alarm should you require your disposal to be uphill from the tank.

PLASTIC or CONCRETE?

Please ask your Taylex Distributor to do a site inspection or use his knowledge of your area to ascertain which tank material will be the most cost effective for a Taylex MAXI Tank install on your block. He will take into account access on your site for a truck and/or a crane against the cost of a plastic vessel or a concrete vessel. He will also monitor the invert depth required to accommodate the 1:60 fall of the drain-line from your house to the tank. Both vessels are cast in one piece and are exceptionally strong – please see The Taylex Difference section in this brochure.

Self Anchoring Tank

The Plastic tank is built with anti-floatation protrusions incorporated into the design. There is no need for chains or concrete to hold the tank in the ground.

The Concrete tank is built with a weight of 6ton and will hold itself in the ground while a routine pump out is conducted.

Lower Invert – Connection pipe

The concrete tank has a lower Invert – 100mm opening where the drain-line from your house connects into the tank. This allows for a gravity feed that can accommodate the long drain-lines (that must fall 1:60) found in many modern house plans where wet areas of the home are spread between several areas of the house.

The standard concrete tank comes with inverts at 470mm & 770mm from the top of the tank. Taller tanks are available with inverts at 1070mm and 1170mm from the top of the tank. This eliminates the need to use a septic tank at both ends of the house. The plastic tank also has a deeper invert although it is a little shallower than the concrete tank. Ask your Taylex Distributor for his advice.

Effluent Disposal Fields - (Trenches etc.)

Your local council will stipulate the type of effluent management allowable in your area. Ask your Taylex Distributor to organise an essential Wastewater Disposal Report to be submitted to council.

Taylex 4000Lt Baffle Walled Septic Tank

A Primary Effluent System

Tank Construction – All Concrete Vessel

Height	2175mm
Tank Diameter	1935mm
Inlet Invert (from Base)	1700mm
Outlet (from Base)	1640mm
Maximum Dry Weight	3.4 tonnes

The Taylex 4000Lt B/W Septic Tank is a standard septic tank with a baffle wall that can be sealed or unsealed or removed as required.

Also available with pump, high level post alarm light and float switch.



5 Chambered Septic Tank

Septic System

Taylex **Maxi** All Purpose Septic Tank

Advanced Primary Effluent System

Makes septic trenches last longer!

The Taylex MAXI Tank is the largest commercially manufactured domestic advanced primary (septic) tank on the market in Australia today.

It has a unique 5 chambered construction in one piece of concrete or plastic with walls (baffles) extending to the lid of the tank. This septic tank is suitable for all homes up to 6 bedrooms.

Available in Concrete or Plastic

*Greasetrap and Septic
All in One Tank*



Effluent Grade

Advanced Primary/Septic

Tank Construction - All CONCRETE Vessel

Height	2300mm
Inlet Invert (from Base)	1530mm & 1830mm
Tank Diameter	2440mm
Operating Capacity	6300Lt
Maximum Dry Weight	6.1 Tonnes

A Concrete "Tall" tank is also available

Tank Construction - All PLASTIC Vessel

Height	2500mm
Inlet Invert (from Base)	1770mm
Tank Footprint	2400mm x 2530mm
Operating Capacity	6066Lt
Maximum Dry Weight	450kg <small>Allow 600kg as all tanks are water tested</small>

Taylex ★★ MAXI All Purpose Septic

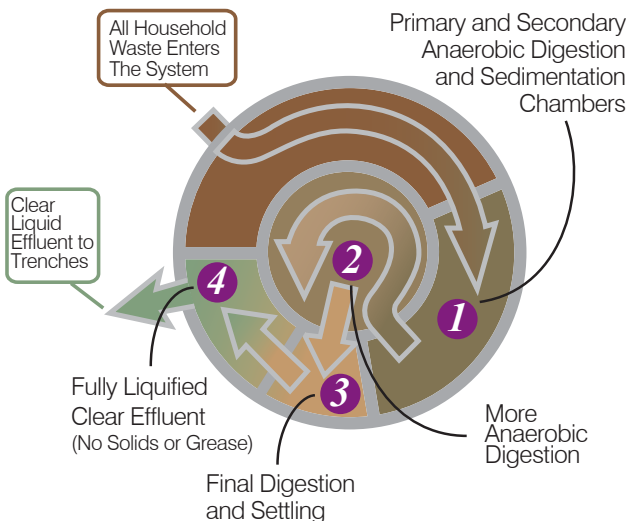

Compared to...

Standard Septic ★

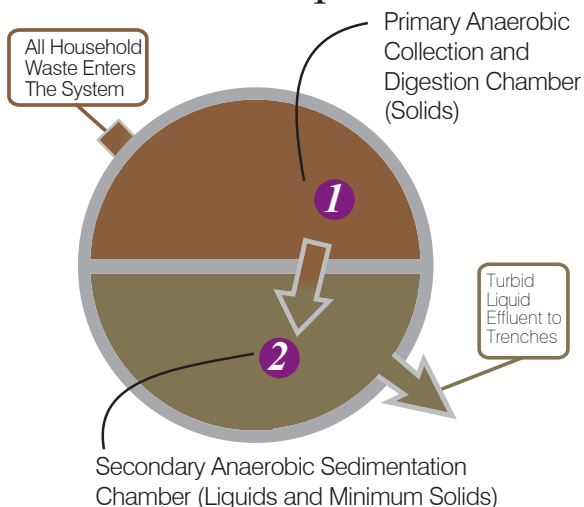

MAXI Tank - Top View

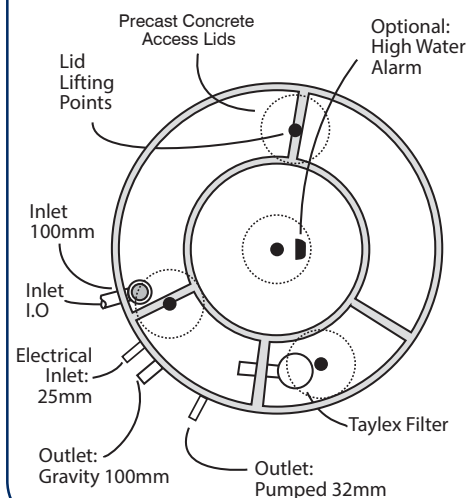

Concrete & Plastic Tanks

15 Year Tank Warranty Includes Internal Compartment Walls... Plus 3 Years Electrical Components Warranty

Taylex Deluxe (Secondary)

15 Persons - For Large Homes

Qld Only

Step 1: All waste from the home enters the primary pre-treatment chamber of the Taylex System with liquid then flowing into the secondary chamber. The time that waste spends in both these anaerobic* chambers allows bacterial action to condition it before it flows into the aeration chamber.

Step 2: The aeration chamber is designed to retain & mix the liquid while aerobic** bacteria digest the organic material. The aerator introduces oxygen by drawing fresh air through the vent and injecting it into the chamber while circulating the entire contents. The aerobic** bacteria multiply rapidly in this oxygen enriched environment and are thoroughly mixed with the pre-treated liquid to ensure complete oxidation of all organic material.

Step 3: The liquid then flows into the clarification chamber for settlement where the remaining organics are further digested by bacteria living on specially designed bio-mass sheets.

Step 4: Pre-treated, aerated and settled, the liquid then passes through a Taylex filter prior to chlorination. The filtered liquid passes through a chlorinator which ensures the disinfection of the reclaimed effluent.

Then your reclaimed effluent is returned to the environment via spray or underground irrigation by a silent pump.

1st Tank Construction – All Concrete (round)

Height	2140mm
Inlet Invert (from Base)	1700mm
Tank Diameter	1930mm
Maximum Dry Weight	4 tonnes

2nd Tank Construction – All Concrete (oblong)

Height	1800mm
Inlet Invert (from Base)	1400mm
Length x Width	3200mm x 1700mm
Maximum Dry Weight	5.2 tonnes

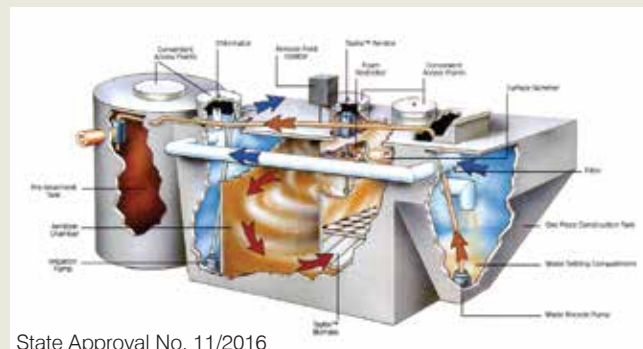

State Approval No. 11/2016

Taylex ABS & Maxi Systems

- One Tank
- One Connection
- One Hole

Applications

NEW HOMES – it's all so simple:

• One Tank • One Hole • One Piece Construction
Which means easier installation by having lower costs for plumbing and excavation – and the system is discreetly hidden in your garden. This, combined with a holding capacity 30% larger than other units means a TAYLEX™ System is the most efficient, cost effective and easily maintained sewage solution available.

EXISTING HOMES – it's a simple process to replace your existing septic system with a strong, safe and reliable TAYLEX™ System. No more grease traps, odours or soggy back yards.

Getting Started

1 Ask our Taylex Consultant to organise a Wastewater Disposal Report (Site & Soil Test for placement of a Effluent Disposal – Spray or subsurface irrigation , trenches etc.). Then you will be aware of what system your Local Council will allow to be placed on your property and we can quote for you.

2 We can then do Site Inspection (if required) to ensure your install will run smoothly. Please be aware that in some cases it is best to install your tank prior to building your home to make sure that access is available.

PLEASE NOTE: Make sure you inform your Taylex Consultant, builder or plumber of any future sheds, pools, driveways or dams. The positioning of these items may impact on the placement of your irrigation area and impeded commissioning of your System prior to you moving in to your new home. Gazetted setback distances need to be adhered to so council final approvals can be obtained.

* Anaerobic - Meaning: without air (Oxygen), The bacteria in an anaerobic environment do not require oxygen to survive and flourish.

** Aerobic - Meaning: with air (Oxygen). The bacteria an aerobic environment do require air to survive. The system introduces extra oxygen into an aerobic chamber to allow these "good" bacteria to multiply and flourish.

The #1 Taylex Difference...

Our Purpose Built Tanks

- Poured or Moulded in One Piece
- No Joins or "Glued in" Compartments
- All Partitions extend to the Lid of the Tank
- NO INTERNAL LEAKAGE

**15 Year Tank Warranty Includes Internal Compartment Walls... Plus
3 Years Electrical Components Warranty***

*ABS and MAXI Systems Only

Concrete Tanks

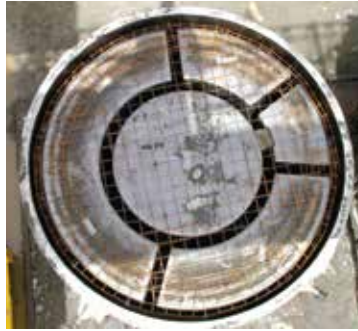

Inverted Mould with Reinforcing Ready for Concrete



Completed Tank Ready for Fitout and Lid

Plastic Tanks



Sectional view of plastic tank internal showing one-piece construction.

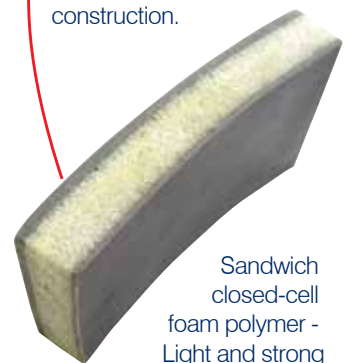

Sandwich closed-cell foam polymer - Light and strong

The Treatment Process - *A living thing*



**Most Wastewater/
Sewage Treatments
are a biological
process for
domestic,
commercial and
municipal
applications.**

A Treatment Plant is a living organism. There are trillions of living bacteria that make the system work properly - even in large city sewage treatment plants! Your Local and City Councils will have laws in place that prevent the dumping of certain chemicals through their drains. Large amounts of chemical will "kill" off their living system and create havoc in their treatment plants... and often does. A city plant is a large scale operation and they will have the excess treatment power to overcome most daily problems.

Your Home Sewage Treatment Plant is a miniature version of the City Plant. Because it is smaller and only designed to treat the amount of waste you produce from your home it will be more noticeable to you if you accidentally "kill" off your living system's bacteria. The bacteria are produced from our bodies and should a "Kill" ever occur within the system it will rebuild the ecosystem again from normal usage once the "Kill Factor" has been removed.

When using your Taylex system we ask that you respect the system and be mindful of the need to provide a safe and happy home for your colony of bacteria to live and work in. Should the balance be upset by mistake (e.g. a bleach product is used etc.) we will help to ascertain the cause and find the remedy. We suggest you read the tips in your Home Owner's Manual to avoid or minimise the use of cleaners etc. that may upset the system. This is not normally an arduous chore but a simple rearrangement of your cleaning products preferences.

Taylex Systems
are either:

Septic – Anaerobic bacteria

Aerated – Anaerobic and Aerobic bacteria



Our Commitment - Service, Reliability & Quality

Professional after sales service together with emergency breakdown response is provided by our qualified service technicians using our modern fleet of service vehicles. Our service technicians are qualified and licensed by the relevant state government authorities ie. Plumbers and Drainers Licensing Board and Wastewater Service Persons Course to ensure that they offer the highest quality in service.

Superior treatment systems with reliable performance...
 Working for you and the environment.
 Protecting your family and the environment.

Call Your Local Authorised Distributor

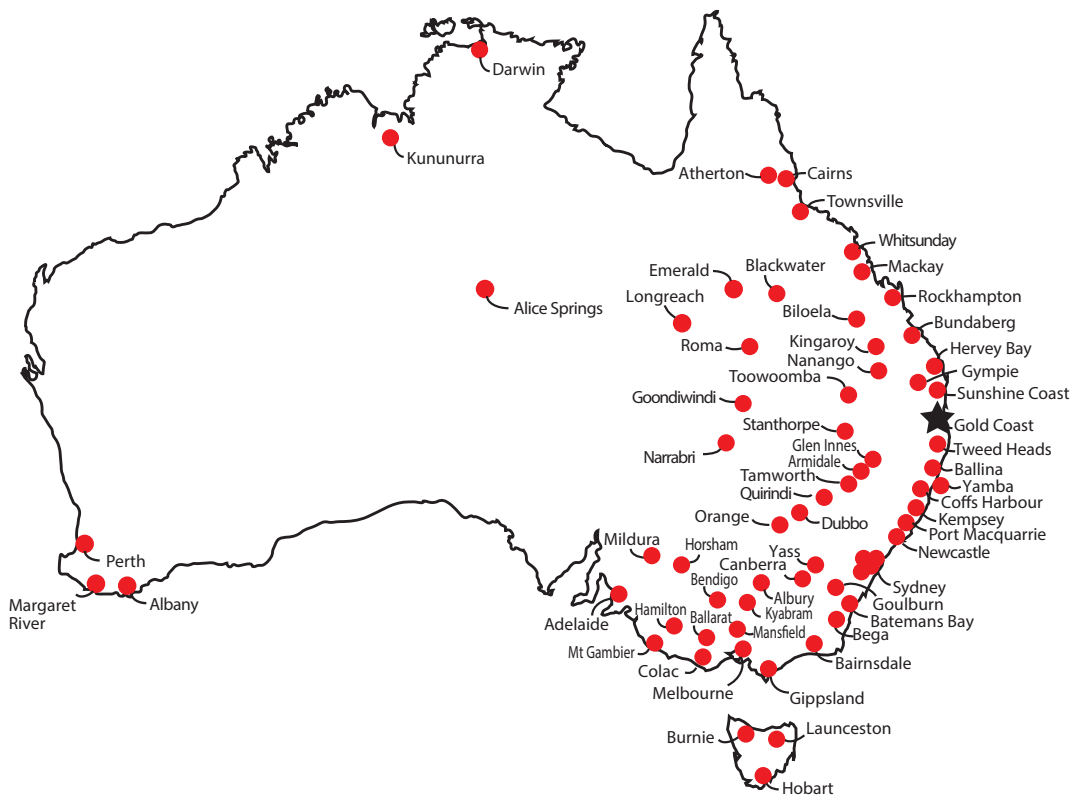

Taylex Since 1969
 Wastewater & Rainwater Specialists
Tanks
 1300 TAYLEX
 www.taylex.com.au

CONTACT YOUR LOCAL DISTRIBUTOR

The Standards Mark refers to the vessels & systems manufactured by Taylex. It does not cover the other items of equipment contained in the system.

Can we also help with your rainwater tank requirements?